

## God Calls Abram

Genesis 12:1-8; 15:1-6

**“For the word of the Lord holds true, and we can trust everything he does.”**  
(Psalm 33:4)

## We can trust God... even when we don't understand.

There's a *lot* kids don't understand. That's why there's school. And soccer practice. And online videos.

Well, here's a secret: There's at least as much that *adults* don't understand. They're just better at hiding it. Adults like to feel smart and in control...even when they aren't.

Don't believe it? Ask an adult to explain “time” to you. Or give you a really good explanation about how brains work. You'll see.

Here's another secret: God actually *does* understand stuff—because he made it. All of it. You can trust God when things you don't understand show up in your life. Or when people you love are in trouble. Or when you feel like nobody loves you, or when something scary is knocking at your door.

In those moments, *trust God*. He understands—and he loves you, too. That means he'll walk with you through anything...even those things you don't understand.

### Talk-Starters

Tell about a time you didn't understand what was happening, but you decided to trust God. What happened?

### Try-This @ Home

Go find a sturdy wall and lean against it. While you're there, think about this: How is leaning on the wall like leaning on and trusting God? Tell him what you think—he'll want to hear your thoughts!



### Explore More @ Home

Trusting God is a great idea! Read Daniel 3:16-18 to meet three tiptop trusters!

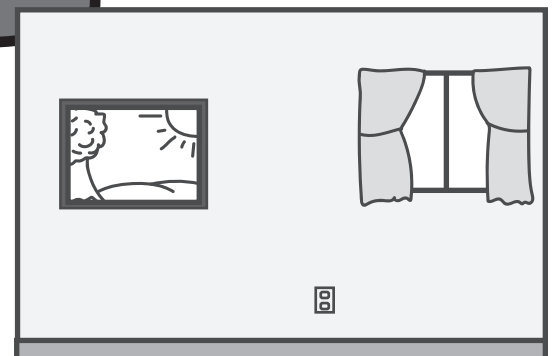

# Make this page fly home!

Fold a flyer. When you get home, see if

...you can get it to safely land on a tabletop.

## Here's how:

- 1 Fold the paper in half lengthwise as shown.

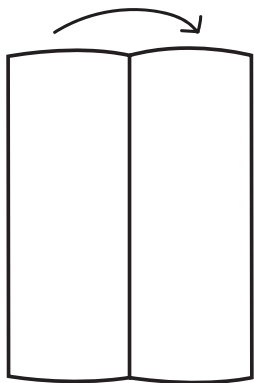

- 2 Unfold, and then fold the top two corners to the center line to create flaps.

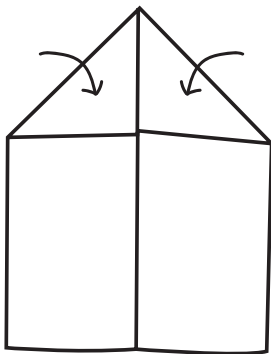

- 3 Fold the peak toward you about an inch from the bottom of the paper.

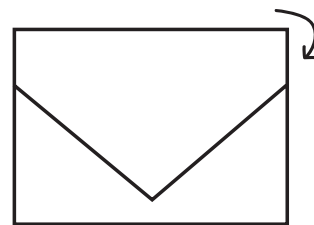

- 4 Fold both top corners into the center line.

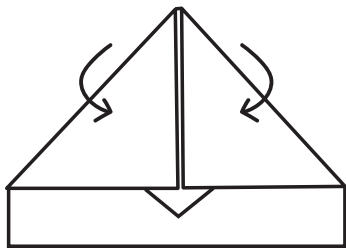

- 5 Fold the little tip over the flaps at the center so they stay in place.

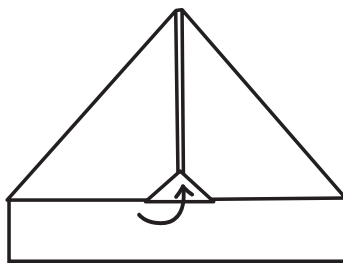

- 6 Fold the plane in half.

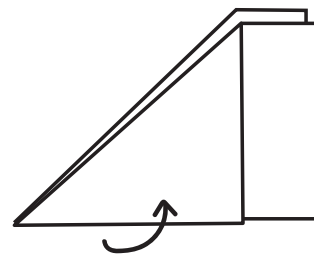

- 7 Fold the wings down.

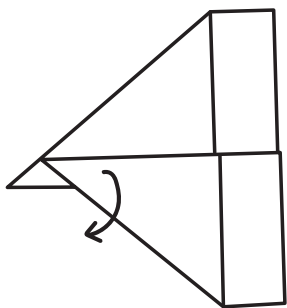

- 8 Fold up the edges of each wing.

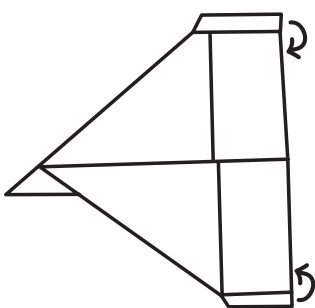

- 9 Take aim, and let it fly!

